



Side View



SANDERS

FA-A0599

2.5ELS + SQC + 2.25ALRTA + 1.5COUNA

FAB - MMO - 03 / NP - 513E

PW = ACC - FA - P4563 (45 x 45cm) PW = ACC - FA - 4562 (50 x 50cm)

ALL PW shown in the above picture are sold separately





Side View



SANDERS

FA-A0599

2.5ELS + SQC + 2.25ALRTA

FAB - MMO - 03

PW = ACC - FA - P4563 (45 x 45cm) PW = ACC - FA - 4562 (50 x 50cm)

ALL PW shown in the above picture are sold separately





Side View



SANDERS

FA-A0599

2.25ALLTA + 1.5COUNA1L + 2.5ERS

FAB - MVE - 112

PW = ACC - FA - P4563 (45 x 45cm)
ALL PW shown in the above picture are sold separately





Side View



SANDERS

FA-A0599

2.5S

NP - 550E





Side View



SANDERS

FA-A0599

2.5S

NP - 550E



SANDERS
FA-A0599

DIMENSION

Updated : 16 / 10 / 2023

Configuration	Width		Seat Width		Depth		Seat Depth		Back Height		Seat Height		Weight		Volume	
	cm	inch	cm	inch	cm	inch	cm	inch	cm	inch	cm	inch	kg	lb	m ³	ft ³
2.5EL, 2.5ER	200	79	180	71	97	38	57	22	85	33	45	18	58	128	1.65	58.23
2.5ERS, 2.5ELS	180	71	160	63	97	38	57	22	85	33	45	18	52	115	1.48	52.41
2EL, 2ER	160	63	140	55	97	38	57	22	85	33	45	18	50	111	1.32	46.59
1.5EL, 1.5ER	110	43	90	35	97	38	57	22	85	33	45	18	32	71	0.91	32.03
1.25EL, 1.25ER	100	39	80	31	97	38	57	22	85	33	45	18	30	67	0.82	29.12
2.5ALLTA, 2.5ALRTA	235	93	182	72	97	38	57	22	85	33	45	18	60	133	1.94	68.42
2.25DBLTA, 2.25DBRTA	235	93	161	63	97	38	57	22	85	33	45	18	60	133	1.94	68.42
2.25ALLTA, 2.25ALRTA	215	85	162	64	97	38	57	22	85	33	45	18	58	128	1.77	62.60
1.5AL	91	36	91	36	97	38	57	22	85	33	45	18	28	62	0.75	26.50
1.5ALLTA, 1.5ALRTA	145	57	91	36	97	38	57	22	85	33	45	18	36	80	1.20	42.22
1.25AL	81	32	81	32	97	38	57	22	85	33	45	18	24	53	0.67	23.58
1.25ALLTA, 1.25ALRTA	135	53	81	32	97	38	57	22	85	33	45	18	34	75	1.11	39.31
RCR,RCL	130	51	92	36	97	38	57	22	85	33	45	18	40	89	1.07	37.85
1.5COUR, 1.5COUL	110	43	90	35	157	62	119	47	85	33	45	18	50	111	1.47	51.84
1.5COUNA	94	37	94	37	157	62	119	47	85	33	45	18	46	102	1.25	44.30
1.5COUNA1L,1.5COUNA1R	94	37	94	37	157	62	119	47	85	33	45	18	46	102	1.25	44.30
COUL, COUR	90	35	70	28	157	62	119	47	85	33	45	18	42	93	1.20	42.41
COUNA	74	29	74	29	157	62	119	47	85	33	45	18	38	84	0.99	34.87
COUNA1L,COUNA1R	74	29	74	29	157	62	119	47	85	33	45	18	38	84	0.99	34.87
SQC	96	38	96	38	96	38	-	-	85	33	45	18	33	73	0.78	27.66
2.5S	220	87	180	71	97	38	57	22	85	33	45	18	64	141	1.81	64.06
2.5SS	200	79	160	63	97	38	57	22	85	33	45	18	60	133	1.65	58.23
2S	180	71	140	55	97	38	57	22	85	33	45	18	56	124	1.48	52.41
RFSTA	80	31	80	31	60	24	-	-	-	-	42	17	16	36	0.20	7.12
ACC-FA-1168	60 x 18 x 15CM, 24"x 7"x 6"(Recommended for seat width 70-80cm)															
ACC-FA-1168L	70 x 18 x 15CM, 28"x 7"x 6"(Recommended for seat width 80-90cm)															

TECHNICAL DATA

SEAT	No-sag Spring
BACK REST	Rubber Webbing
SEAT CUSHION	D/38S + D/22 + Inner coil (RFSTA : D/38S + D/22)
BACK REST CUSHION	D / 38S + 50% Feather + 50%Loose fibre
SOFA LEGS (front & rear)	
code(front)	MLG-1798-23L
code(rear)	MLG-1316-23L
material	Metal
height	160mm (MLG-1798-23L) 100-150mm (MLG-1316-23L)
colour	23 = Matte Black

FABBRICA reserves the right, at its discretion, to discontinue and make changes at any time. All products are handmade and are subjected to marginal difference in the measurements. This design is copyrighted and shall not be used or reproduced without the consent of FABBRICA.

SANDERS
FA-A0599

DIMENSION

SOFAS

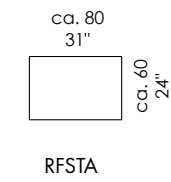
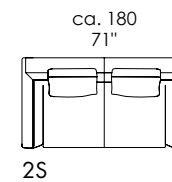
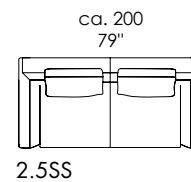
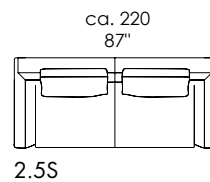
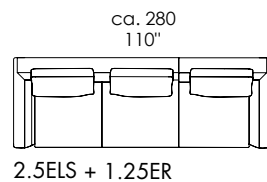
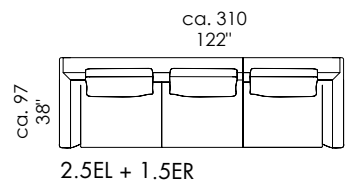

OTTOMANS

MODULAR ELEMENTS

IMPORTANT

All modular elements can be selected as either a left or right version. Left and right are taken to be as facing the piece.

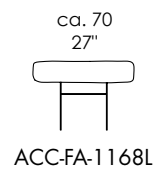
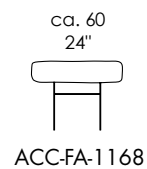
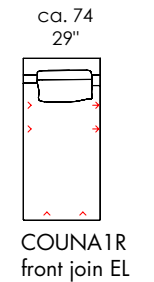
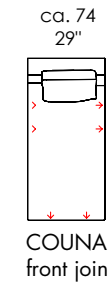
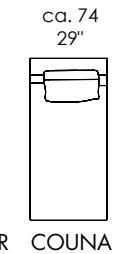
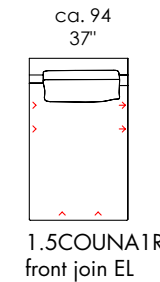
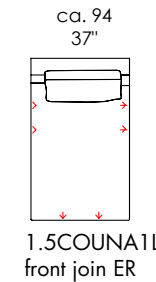
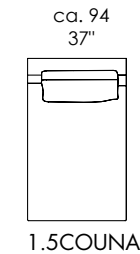
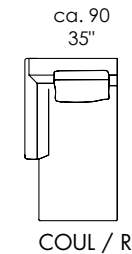
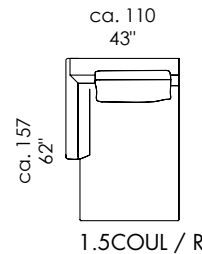
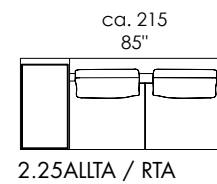
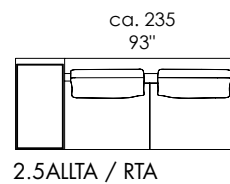
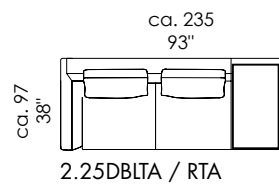
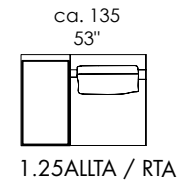
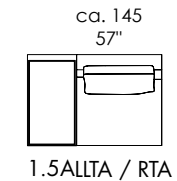
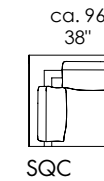
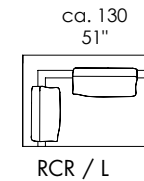
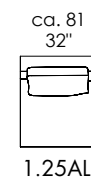
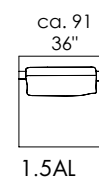
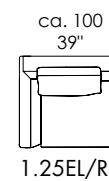
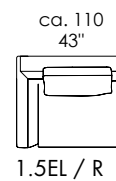
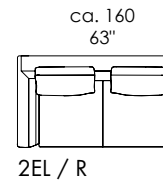
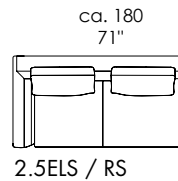
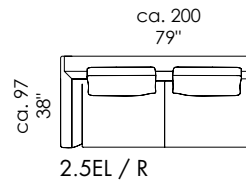

SANDERS
FA-A0599

COMBINATION EXAMPLES

IMPORTANT

All modular elements can be selected as either a left or right version. Left and right are taken to be as facing the piece.

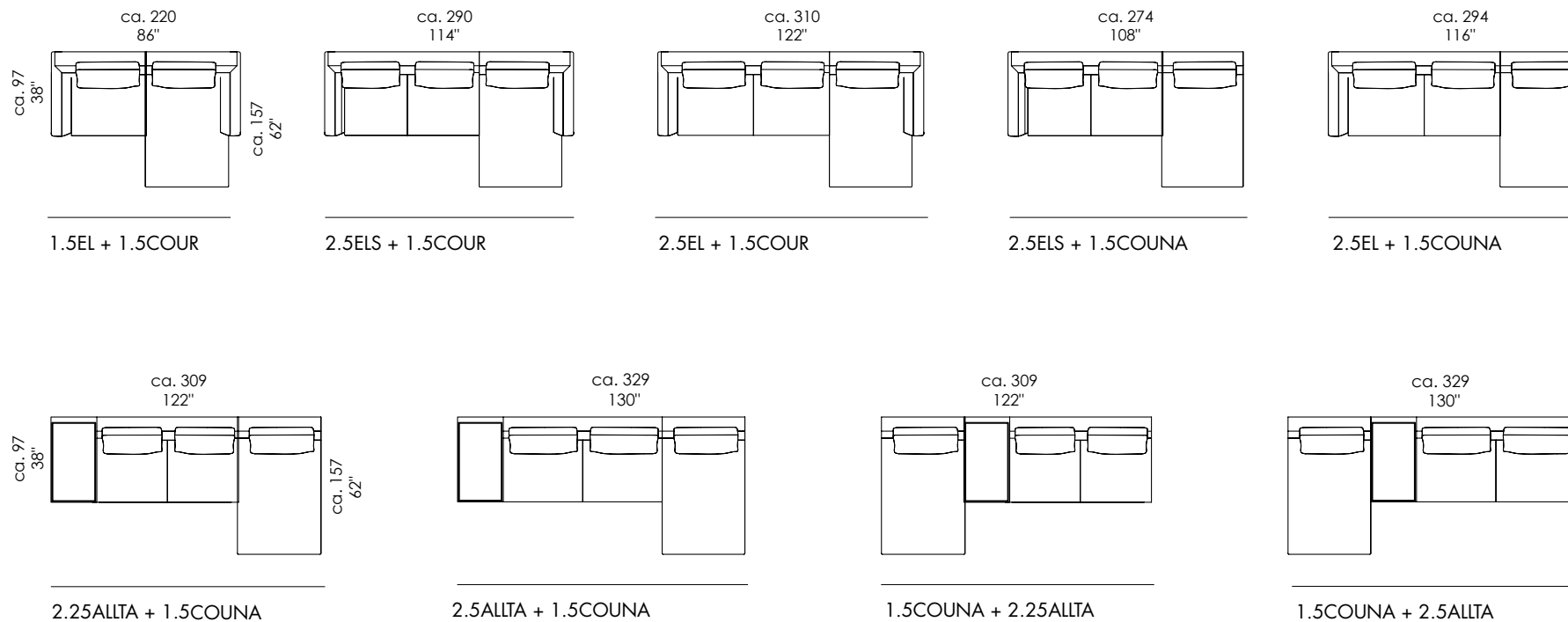

SANDERS
FA-A0599

COMBINATION EXAMPLES

IMPORTANT

All modular elements can be selected as either a left or right version. Left and right are taken to be as facing the piece.

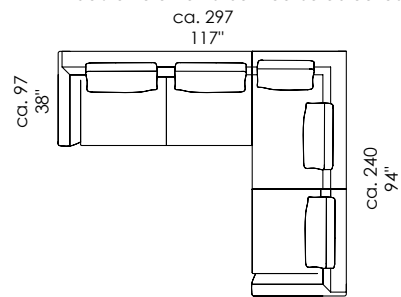

2.5EL + RCR + 1.5ER

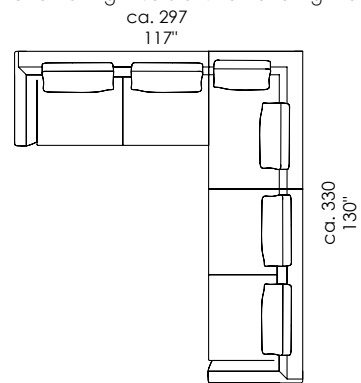

2.5EL + RCR + 2.5ER

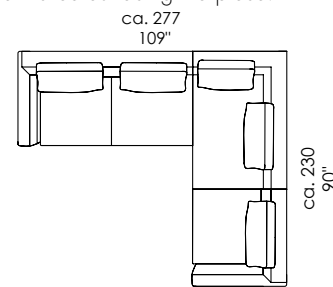

2.5ELS + RCR + 1.25ER

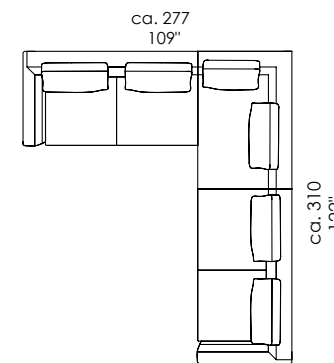

2.5ELS + RCR + 2.5ERS

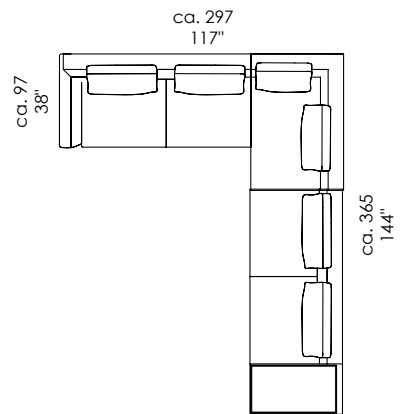

2.5EL + RCR + 2.5ALRTA

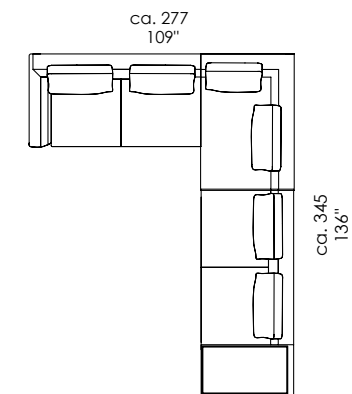

2.5ELS + RCR + 2.25ALRTA

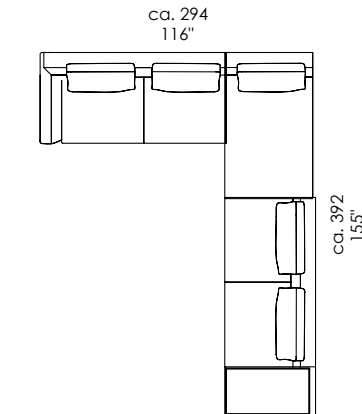

2.5EL + 1.5COUNA1L + 2.5ALRTA

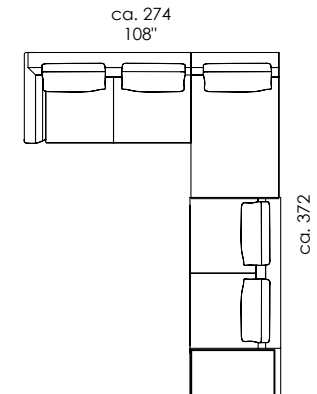

2.5ELS + 1.5COUNA1L + 2.25ALRTA

FABBRICA reserves the right, at its discretion, to discontinue and make changes at any time. All products are handmade and are subjected to marginal difference in the measurements. This design is copyrighted and shall not be used or reproduced without the consent of FABBRICA.

SANDERS
FA-A0599

COMBINATION EXAMPLES

IMPORTANT

All modular elements can be selected as either a left or right version. Left and right are taken to be as facing the piece.

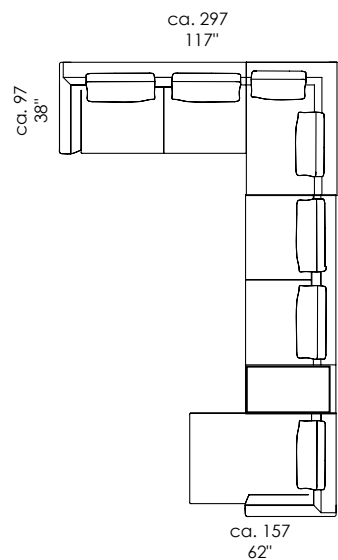

2.5EL + RCR + 2.5ALRTA +
1.5COUR

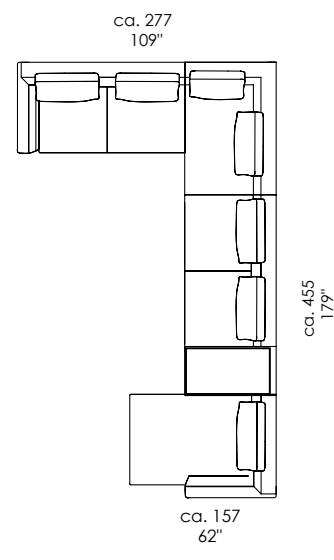

2.5ELS + RCR + 2.25ALRTA
+ 1.5COUR

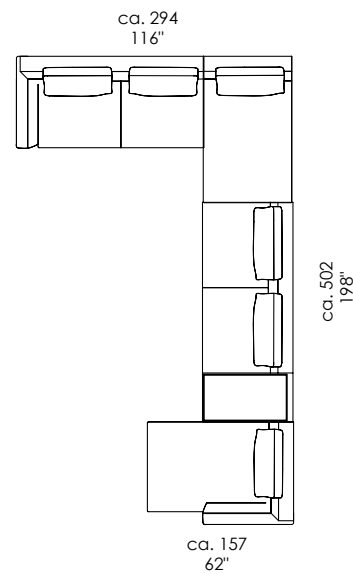

2.5EL + 1.5COUNA1L +
2.5ALRTA + 1.5COUR

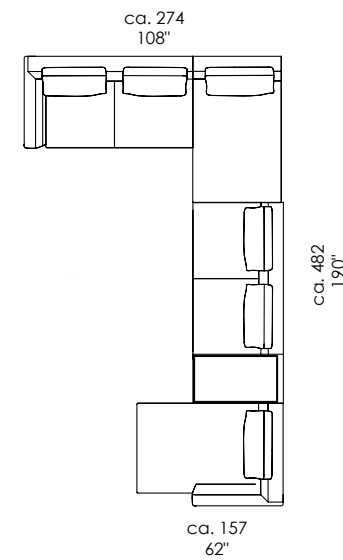

2.5ELS + 1.5COUNA1L +
2.25ALRTA + 1.5COUR